

INNOVATION MADE IN GERMANY

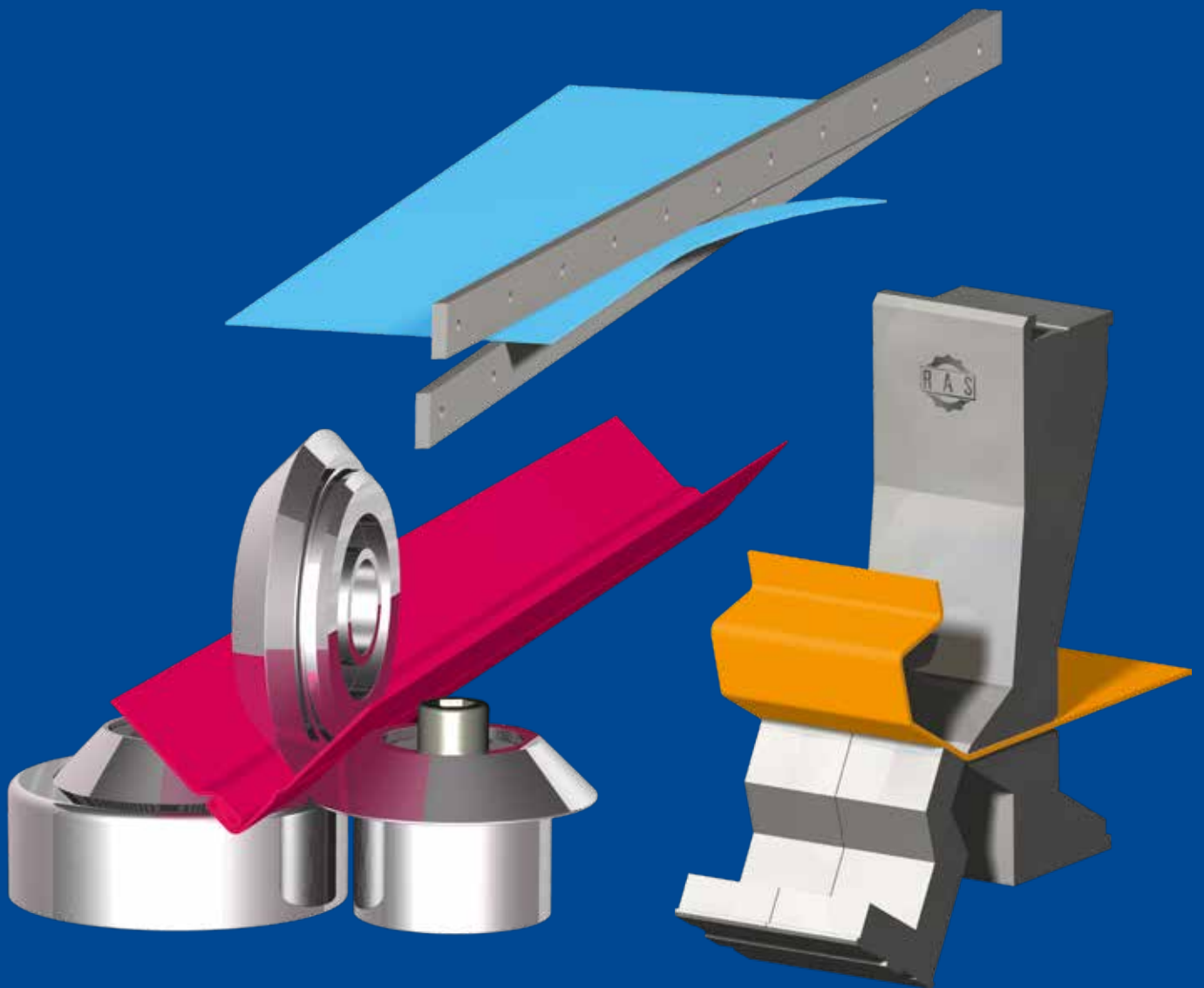

# Production Program



CUTTING

BENDING

FORMING

SOFTWARE

# Bending Centers

## ProfileCenter

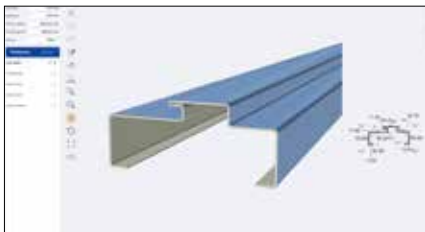

Office software with one-click programming starting from a STEP, DXF, GEO file of the part. No expert knowledge required. Fast, safe, precise.

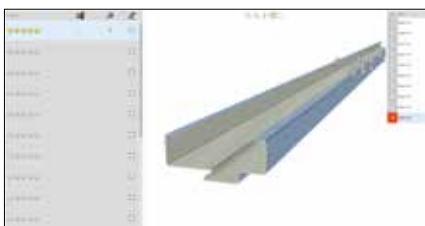

The best bending sequences are shown according to the highest the 5-star ranking.

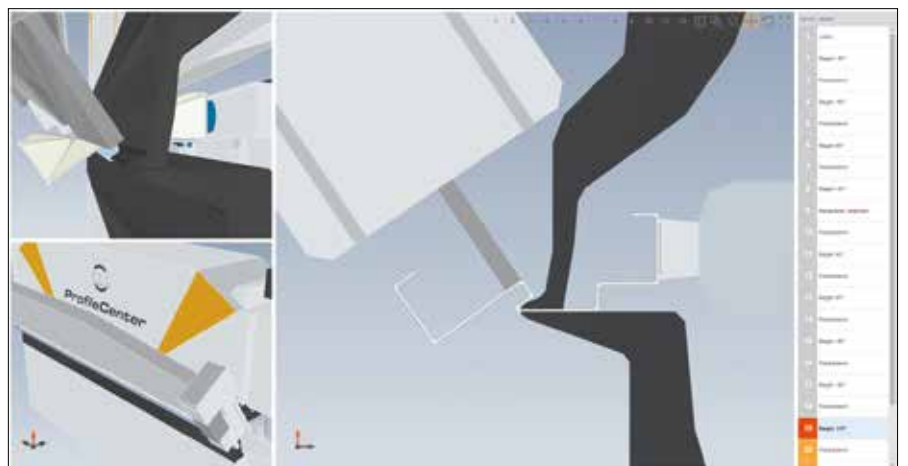

The 3D simulation shows the folding sequence and possible collisions. New products can already be evaluated during the design process.



Secured bending accuracy due to automatic alignment of the supplied blanks.



Complex geometries can be bent due to the large free space around the tools.



Automatic bending with fast cycle times. The workpiece does not have to be positioned at the stops during bending process.

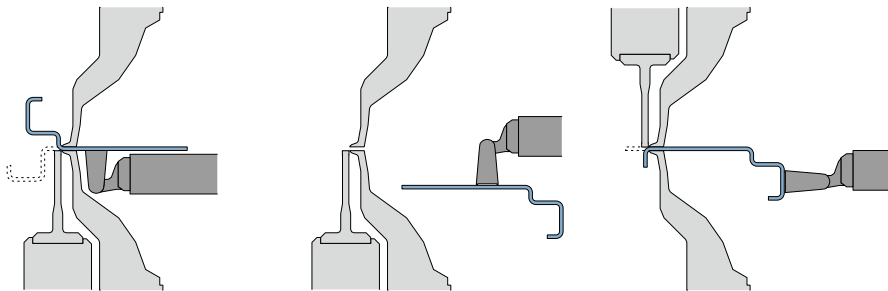

Automatic bending of complex profiles without operator intervention. The unique FlexGripper handling system automatically changes its gripping position when needed.



Scratch-free bending of pre-coated or galvanized sheets as well as of stainless steel as the folding beam tool rolls away with the flange.

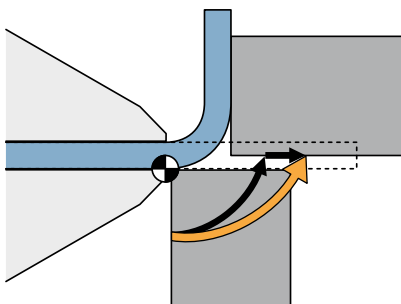

Folding beam movement for scratchfree bending.



Precise flange dimensions, angles and straightness of the profiles.



Batch size 1 production is possible as the machine automatically adapts to changing sheet thicknesses and material types.

Technical data	Sheet thickness max.	Blank size min.	Blank size max.
ProfileCenter RAS 79.30	2.0 mm	100 x 600 mm	700 x 3200 mm

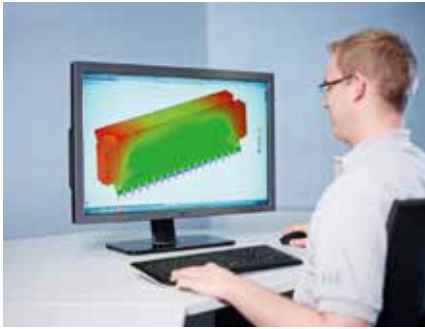

Design



Sawing



Plasma cutting



Milling



Turning



Grinding



Welding



Powder coating



Assembly



Electrical assembly



Quality inspection



RAS - Regional production for global sustainability



INNOVATION MADE IN GERMANY



09. 2018



Headquarters in Sindelfingen. In the foreground „Steel object“.



Efringen - factory and artwork



RAS Systems LLC in Georgia, USA

All sheet thickness refer to 400 N/mm<sup>2</sup> tensile strength. Subject to changes. Pictures may show options.



Founder Wilhelm Reinhardt



Managing Directors Rainer Stahl and Willy Stahl

**RAS Reinhardt Maschinenbau GmbH**

Richard-Wagner-Straße 4-10 | 71065 Sindelfingen

Fon: + 49-7031-863-0 | [info@RAS-online.de](mailto:info@RAS-online.de)

[www.RAS-online.de](http://www.RAS-online.de)